

Parts List

*Quantities change depending on product type.

Bench Top (x1)

Bench Support (x2) / (x3) / (x5)

14g x 75 mm Hex Screw (x8) / (x15) / (x25)

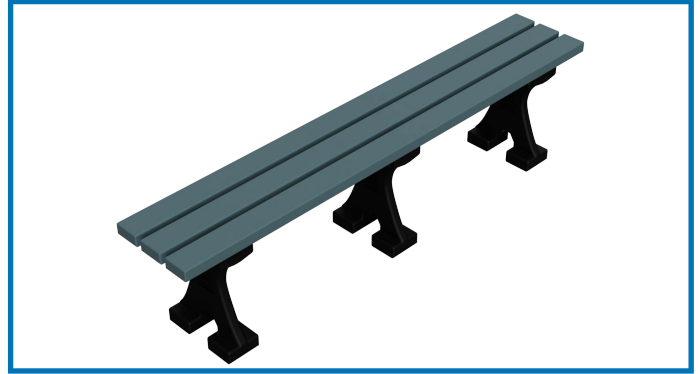

Instructions

Step 1 Place bench slats face down on a flat surface.

Step 2 Using the 75 mm hex screws supplied, affix the supports onto the slats, taking care not to over-tighten as this could strip the thread in the plastic.

Step 3 Once all screws have been tightened turn the bench over and place into position.

Diagram

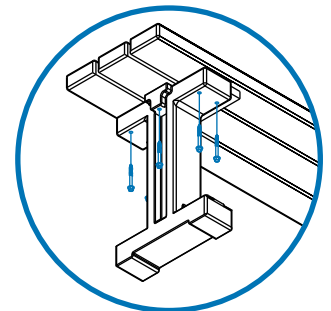
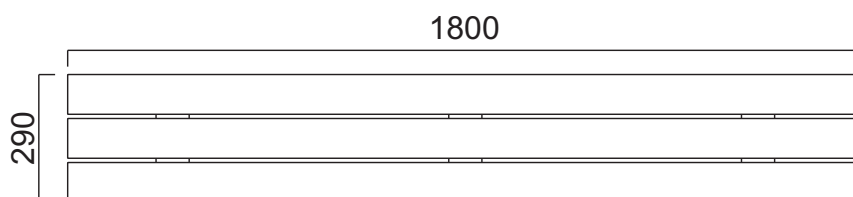

All dimensions are in millimetres (mm) unless specified.

If you require further assistance, please contact your supplier.

Rev: 3